

# MORE WIDTH, MORE DEPTH, MORE TOOLS

P20

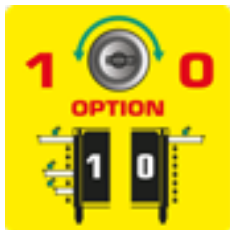

**Workshop trolley P20**  
with 8 compartments  
873.2008



**DUO Lock** Brilliant locking system



**8 Drawers** each load capacity up to 50 kg



Stable **ball bearing**



**Plastic Surface**



**Lock** lockable

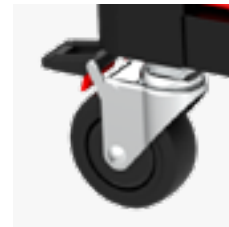

**Anti-static castors** with brakes



Integrated **corner protection**



**Paper roll holder** included



**Can holder** included

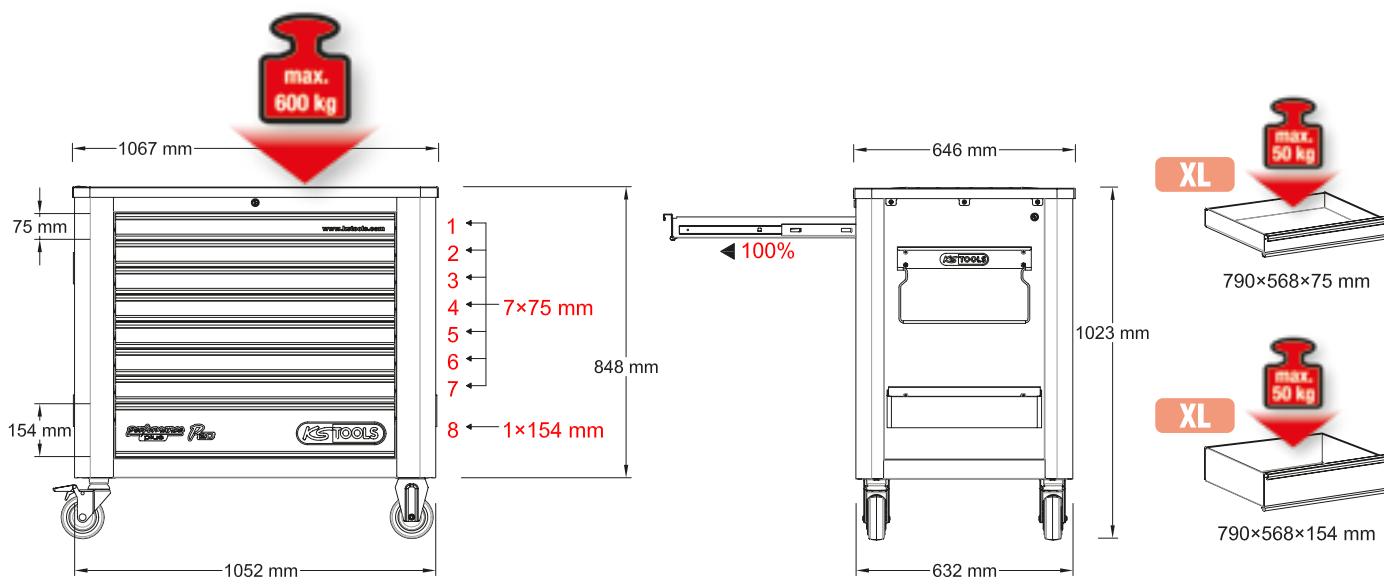

# P20

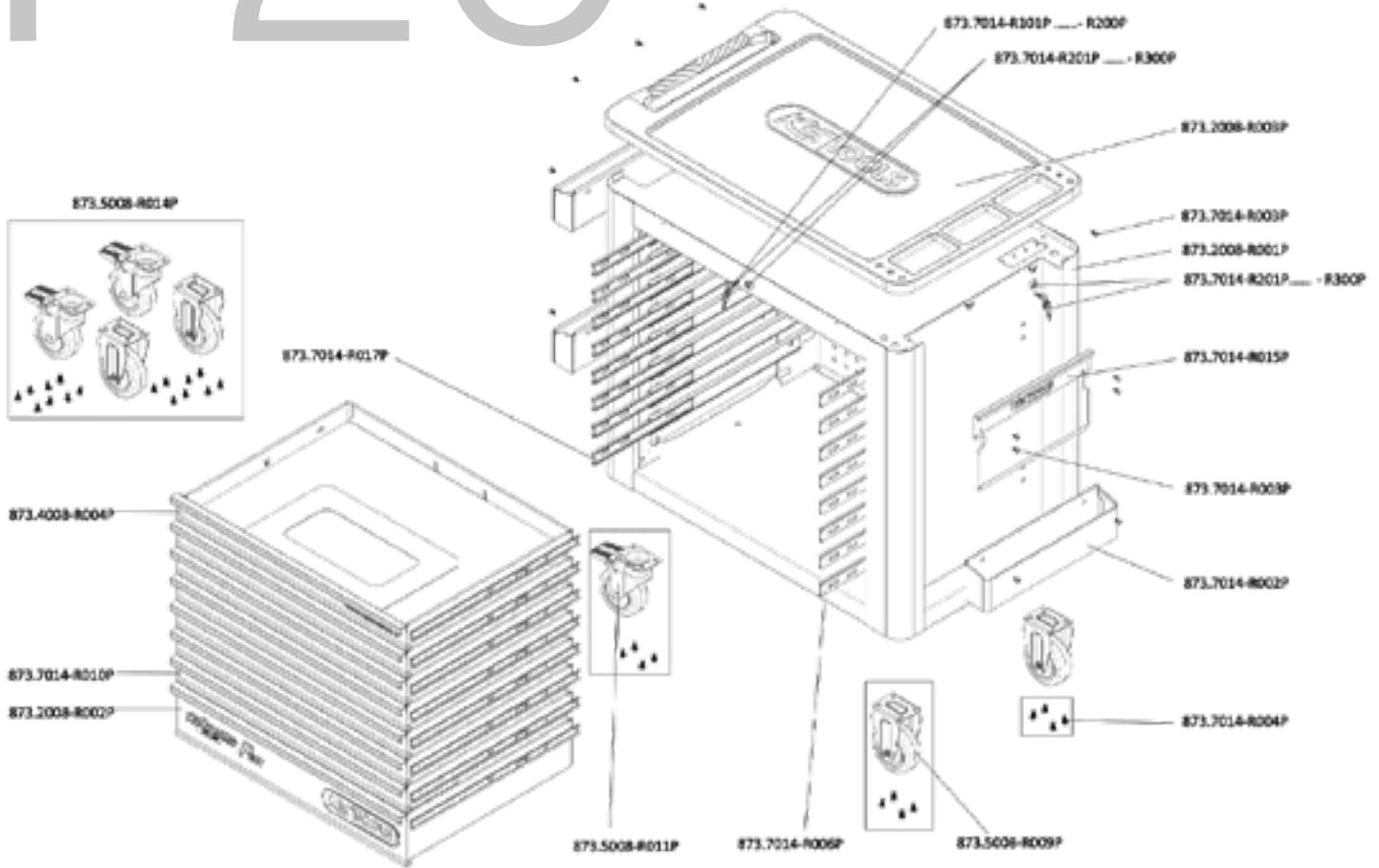

## INDIVIDUAL PARTS LIST

Art.-Nr.	Description	amount
873.7014-R101P...	Replacement key for PERFORMANCEplus workshop trolley lock number xyz	2
873.7014-R201P...	Lock with 2 keys for PERFORMANCEplus workshop trolley lock number xyz	2
873.2008-R001P	Body of workshop trolley	1
873.2008-R002P	Compartment with logo and ball-bearing guide, 755x568x145 mm	1
873.2008-R003P	Plastic work surface with handle	1
873.4008-R004P	Compartment with website and ball-bearing guide, for workshop trolley P20/P30, 785x568x65 mm	1
873.5008-R009P	Fixed castors for PERFORMANCEplus workshop trolley, incl. screws	2
873.5008-R011P	Swivel castors with brakes, for PERFORMANCEplus workshop trolley, incl. screws	2
873.5008-R014P	Roller set for PERFORMANCEplus workshop trolley, incl. screws	1
873.7014-R002P	Can holder for PERFORMANCEplus workshop trolley P20/P30/P35/P40/P45	3
873.7014-R003P	M6x12 screw (1 pcs.) for PERFORMANCEplus workshop trolley accessories	16
873.7014-R004P	M8 screws for PERFORMANCEplus workshop trolley rollers (16 pcs.)	1
873.7014-R006P	Full extension (with ball-bearing guide) with automatic retraction	8
873.7014-R010P	Compartment with ball-bearing guide, for workshop trolley P20/P30/P45, 785x568x65 mm	6
873.7014-R015P	Paper roll holder for PERFORMANCEplus workshop trolley P20/P30/P35/P40/P45	1
873.7014-R017P	Full extension (with ball-bearing guide) with automatic retraction	8



**873.7014-R101P...R200P**  
Replacement key for lock number xyz



**873.7014-R201P...R300P**  
Lock with 2 keys, lock number xyz



**873.7014-R006P**  
Full extension (with ball-bearing guide) with automatic retraction, right



**873.7014-R017P**  
Full extension (with ball-bearing guide) with automatic retraction, left

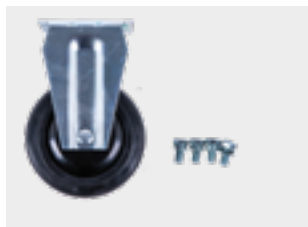

**873.5008-R009P**  
Fixed castors, incl. screws



**873.5008-R011P**  
Swivel castors with brakes, incl. screws



**873.5008-R014P**  
Roller set, incl. screws



**873.2008-R003P**  
Plastic work surface with handle



**873.4008-R004P**  
Compartment with website and ball-bearing guide, 785x568x65 mm



**873.7014-R010P**  
Compartment with ball-bearing guide, 785x568x65 mm



**873.2008-R002P**  
Compartment with logo and ball-bearing guide, 755x568x145 mm



**873.7014-R002P**  
Can holder including screws, W = 445 mm



**873.7014-R015P**  
Paper roll holder including screws, W= 400 mm

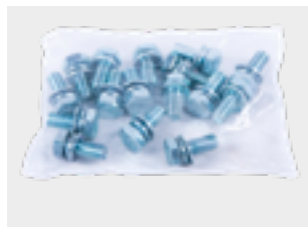

**873.7014-R004P**  
M8 screws (16 pcs.)



**873.7014-R003P**  
M6x12 screw (1 pcs.)



**873.2008-R001P**  
Body of workshop trolley



„Doesn't exist“  
doesn't exist!

---

# **EACH TROLLEY IS UNIQUE**

**Tool holders, pipe holders, storage shelves,  
magnetic shells, clamps, holders and hooks:  
The extensive range of accessories for  
Performance Plus fulfils every wish and turns  
your workshop trolley into your personal  
one-of-a-kind piece. Extend your performance!**

**FREELY CONFIGURABLE –  
EVEN AFTER PURCHASING**

**Fully tailored  
to your needs**

**HOLDERS FOR ALL  
TYPES OF TOOLS**

# ACCESSORIES

- Accessories suitable for hole measurements  
10 x 10 mm – hole distance 38 mm
- fixing screws included
- baseplate thickness 1.5 mm
- galvanised steel plate



**860.0855**  
Pipe holder, Ø 60mm



**860.0856**  
Pipe holder, Ø 100mm

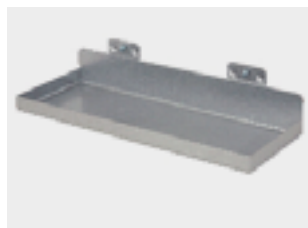

**860.0857**  
Storage shelf without partition,  
350x125mm



**860.0858**  
Storage shelf without partition,  
450x150mm



**860.0859**  
Lin bin holder single, size 7+8



**860.0870**  
Universal tool holder self drill,  
390x45mm



**860.0871**  
Universal tool storage box,  
55x310x125mm

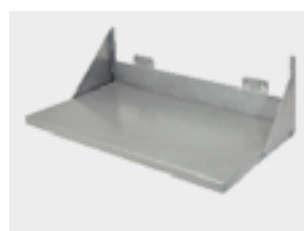

**860.0878**  
Sheet steel tray, 435x250mm



**860.0873**  
Socket holder, 9 holes, 390x30mm



**860.0879**  
Paper roll holder, 355mm



**860.0880**  
Document holder, 220x310mm



**860.0881**  
Works order holder, 220x310mm



**860.0886**  
Drill holder for MK 2 and MK 3  
shafts, 16 holes



**860.0882**  
Magnet set, Ø 25mm, red, pack of 10



**860.0883**  
Magnet set, Ø 25mm, green, pack of 10



**860.0884**  
Magnet set, Ø 25mm, blue, pack of 10



**860.0887**  
Bit holder, 7 holes, 150x35mm



**860.0872**  
Hexagon socket holder, 11 holes, 145x70mm



**860.0894**  
Socket holder for 1/2" sockets, 6 holes



**860.0895**  
Socket holder for 1/2" sockets, 13 holes



**860.0801**  
Tool holder with straight end Ø 6mm, 50mm



**860.0802**  
Tool holder with straight end Ø 6mm, 100mm



**860.0803**  
Tool holder with straight end Ø 6mm, 150mm



**860.0820**  
Double tool holder with straight end Ø 6mm, 35mm



**860.0821**  
Double tool holder with straight end Ø 6mm, 50mm



**860.0822**  
Double tool holder with straight end Ø 6mm, 75mm



**860.0804**  
Tool holder with angled hook end Ø 6mm, 50mm



**860.0805**  
Tool holder with angled hook end Ø 6mm, 100mm



**860.0806**  
Tool holder with angled hook end Ø 6mm, 150mm



**860.0807**  
Tool holder with angled hook end Ø 6mm, 200mm



**860.0812**  
Double tool holder with angled hook end, Ø 6 mm, 35mm



**860.0813**  
Double tool holder with angled hook end, Ø 6 mm, 50mm



**860.0814**  
Double tool holder with angled hook end, Ø 6 mm, 75mm



**860.0815**  
Double tool holder with angled hook end, Ø 6 mm, 150mm



**860.0809**  
Tool holder with vertical hook end Ø 6mm, 35mm



**860.0810**  
Tool holder with vertical hook end Ø 6mm, 75mm



**860.0811**  
Tool holder with vertical hook end Ø 6mm, 125mm



**860.0816**  
Double tool holder with vertical hook end, Ø 6 mm, 35mm



**860.0817**  
Double tool holder with vertical hook end, Ø 6 mm, 50mm

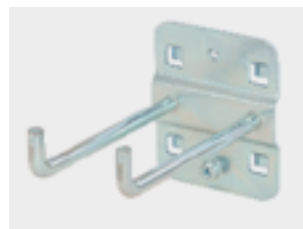

**860.0818**  
Double tool holder with vertical hook end, Ø 6 mm, 75mm

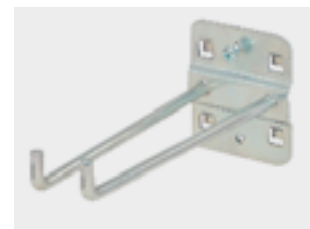

**860.0819**  
Double tool holder with vertical hook end, Ø 6 mm, 150mm



**860.0824**  
Tool clip, single small, Ø 6mm



**860.0825**  
Tool clip, single small, Ø 10mm



**860.0826**  
Tool clip, single small, Ø 13mm



**860.0827**  
Tool clip, single small, Ø 16mm



**860.0828**  
Tool clip, single small, Ø 19mm



**860.0829**  
Tool clip, double small, Ø 6mm



**860.0830**  
Tool clip, double small, Ø 10mm



**860.0831**  
Tool clip, double small, Ø 13mm



**860.0832**  
Tool clip, double small, Ø 16mm



**860.0833**  
Tool clip, double small, Ø 19mm



**860.0834**  
Tool clip, single large, 25mm



**860.0835**  
Tool clip, single large, 28mm



# ACCESSORIES



**860.0836**  
Tool clip, single large, 32mm



**860.0823**  
Angled hook for nuts and sockets  
Ø 6mm



**860.0837**  
Pliers holder depth 20mm, 35mm



**860.0838**  
Pliers holder depth 20mm, 55mm



**860.0839**  
Pliers holder depth 20mm, 75mm



**860.0840**  
Round holder, 25x65mm



**860.0841**  
Power tool holder, Ø 40mm



**860.0842**  
Power tool holder, Ø 60mm



**860.0843**  
Power tool holder, Ø 80mm



**860.0844**  
Tool holder 3 way, Ø 6mm, 150mm



**860.0874**  
Cable holder, 150mm



**860.0875**  
Cable holder, 200mm



**860.0876**  
Tool holder for euro blister packaging, 125mm



**860.0877**  
Tool holder for euro blister packaging, 150mm



**860.0845**  
Six way tool holder hook ends 45°  
angled



**860.0860**  
Base plate, small



**860.0861**  
Base plate, large



**860.0862**  
Lin bin holder, 550x40mm



**860.0863**  
Lin bin holder, 550x60mm



**860.0864**  
Spanner holder tapered for 10 spanners, 145mm



**860.0865**  
Spanner holder tapered for 10 spanners, 225mm



**860.0866**  
Can holder Ø 70mm, 100mm

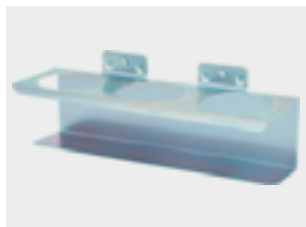

**860.0867**  
Can holder Ø 70mm, 300mm

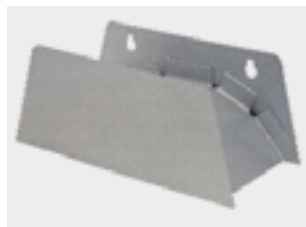

**860.0868**  
Pipe holder 230x70mm

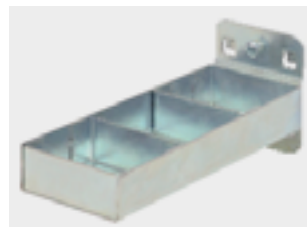

**860.0847**  
Small component tray with partition, 150x55mm



**860.0848**  
Small component tray without partition, 150x55mm



**860.0869**  
Universal tool holder self drill, 120x70mm

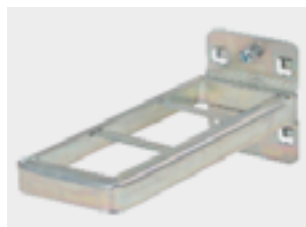

**860.0846**  
Combination holder 150x55mm



**860.0849**  
Spanner holder horizontal, 8 holes



**860.0850**  
Screwdriver holder, 6 holes, 150x55mm



**860.0851**  
Screwdriver holder, 12 holes, 150x55mm



**860.0852**  
Drill- and hexagon socket holder, 14 holes



**860.0853**  
Drill- and hexagon socket holder, 28 holes



**860.0854**  
Saw holder, 4 holes, 150mm

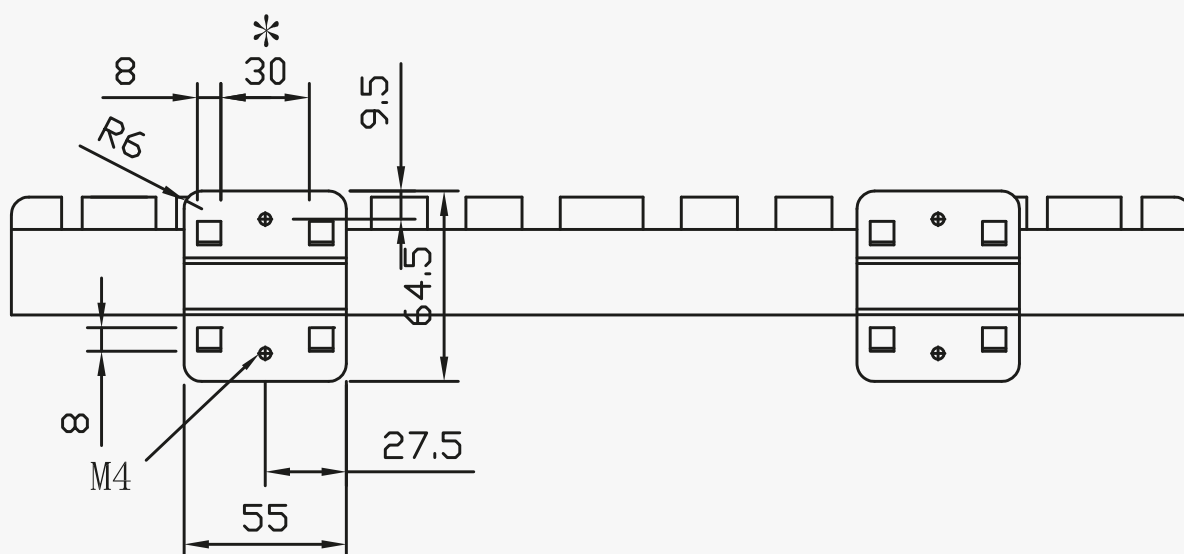

# HIDE YOUR TREASURE UNDER THE HOOD

If you work with Performance Plus, you probably aren't interested in knocking off work so quickly. But when the time does come, you can cover your workshop trolley with the matching hood to protect it from dust and scratches.



P20

860 mm



1290 mm

685 mm

**873.0020**Cover for workshop trolley P20,  
1290x685x860 mm